

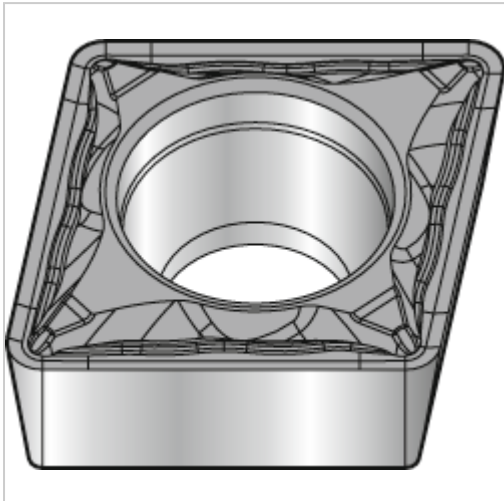

Wendeschneidplatte ZrCN CCMT 060204 FP WM25CT



WIDIA

7,15 €

Preise exkl. MwSt. zzgl. Versandkosten

Artikelnummer: **190007WM25CT**

Eigenschaften

Bearbeitung:	Schlichten
Beschichtung:	ZrCN
Hauptanwendung:	Edelstahl
ISO-Code:	CCMT 060204 FP
Schnitt:	glatter schnitt

Ausführungen

Code	Schneidstoff	VE	Preis/VE
190007WM25CT	WM25CT	1 Stück	7,15 €
190007WP25CT	WP25CT	1 Stück	7,15 €
190007WS25PT	WS25PT	1 Stück	7,15 €